

Usage Notice

<i>Precautions</i>	3
<i>Eye Safety Warnings</i>	5

Introduction

<i>Product Features</i>	6
<i>Package Overview</i>	7
<i>Product Overview</i>	8
<i>Main Unit</i>	8
<i>Projector Panel</i>	9
<i>DVD Panel</i>	9
<i>Connection Ports</i>	10
<i>Remote Control</i>	11

Installation

<i>Setting up the Projector</i>	12
<i>Connecting the Computer</i>	12
<i>Connecting the Video</i>	13
<i>Connecting the Audio Input</i>	14
<i>Connecting the Audio Output-(External Subwoofer/Stereo System)</i>	14
<i>Connecting the Audio Output-(2.1 Channel/5.1 Channel)</i>	15
<i>Powering On/Off the Projector</i>	16
<i>Powering On the Projector</i>	16
<i>Turn On the DVD Player</i>	17
<i>Powering Off the Projector</i>	18
<i>Warning Indicator</i>	19
<i>Adjusting the Projected Image</i>	20
<i>Adjusting the Projector's Height</i>	20
<i>Adjusting the Projector's Focus</i>	21
<i>Adjusting the Projection Image Size</i>	21
<i>Adjusting the Aspect Ratio of the Image</i>	22
<i>Adjusting the Sloping Image</i>	23

User Controls

<i>Control Panel & Remote Control</i>	24
<i>Using the Remote Control</i>	25

TABLE OF CONTENTS

<i>Using the Projector Panel</i>	26
<i>Using the DVD Panel</i>	26
<i>On-screen Display Menus</i>	27
<i>How to Operate Projector Menu</i>	27
<i>Menu Tree for Projector</i>	28
<i>Language</i>	29
<i>Image-I</i>	30
<i>Image-II</i>	32
<i>Display</i>	35
<i>System</i>	37
<i>Lamp setting</i>	38
<i>How to Operate WMA/MP3/JPEG Program</i>	39
<i>How to Operate DVD Menu</i>	40
<i>Menu Tree for DVD</i>	41
<i>System Setup</i>	42
<i>Language Setup</i>	44
<i>Audio Setup</i>	45
<i>Video Setup</i>	46

Maintenance

<i>Troubleshooting</i>	47
<i>Image Problems</i>	47
<i>Intermission Problems</i>	49
<i>LED Problems</i>	49
<i>DVD Player Problems</i>	50
<i>Sound Problems</i>	51
<i>Remote Control Problems</i>	51
<i>Replacing the Lamp</i>	52

Precautions



Please follow all warnings, precautions, and maintenance procedures as recommended in this user's guide.

- To reduce the risk of fire or electric shock, do not expose this product to rain or moisture.
- To prevent the risk of electric shock, do not open or disassemble the product.
- Please allow the unit to cool down before changing the lamp; carefully follow the lamp replacement instructions listed under "Replacing the lamp".
- This product self-detects the life of the lamp and will display a warning message when the lamp is about to expire. Be sure to replace the lamp when the warning message is displayed.
- After installing a new lamp, reset the lamp life using the on-screen menu.
- Before turning off the product, follow the cooling fan to run for several minutes.
- Turn on the projector first and then select the signal sources.
- Do not use lens cap when projector is in operation.
- When the lamp reaches the end of its life, it will burn out and may make a loud "popping" sound. If this occurs, the projector will not turn back on until the lamp module has been replaced. To replace the lamp, follow the procedures listed under "Replacing the Lamp".

USAGE NOTICE

Do:

- ■ Turn off the product before cleaning.
- ■ Use a soft cloth moistened with mild detergent to clean the display housing.
- ■ Disconnect the power plug from AC outlet if the product is not being used for a long period of time.

Do not:

- ■ Block the slots and openings on the unit provided for ventilation.
- ■ Place the unit under direct sunlight.
- ■ Use abrasive cleaners, waxes or solvents to clean the unit.
- ■ Use under the following conditions:
 - Extremely heat, cold or humidity.
 - In areas susceptible to excessive dust and dirt.
 - Near any appliance generating a strong magnetic field.

Eye Safety



- ■ Avoid staring directly into the projector beam at all times.
- ■ Minimize standing facing into the beam. Keep your back to the beam as much as possible.
- ■ Use of a stick or laser pointer to avoid the need for the user to enter the beam is recommended.
- ■ Ensure that projectors are located out of the sight line from the screen to the audience; this ensures that, when presenters look at the audience, they do not also have to stare at the projector lamp. The best way to achieve this is by ceiling-mounting rather than floor or table-mounting the projector.
- ■ When projector is used in a classroom, adequately supervise students when they are asked to point out something on the screen.
- ■ In order to minimize the lamp power needed to project a visible presentation, use room blinds to reduce ambient light levels.

Product Features

This product is a 480p single chip DLP™ projector with built-in DVD player featuring:

- ■ Single 16:9 854x480 chip DLP™ technology
- ■ Uses 7 segment GRBWGRB color wheel
- ■ IR remote control
- ■ User-friendly multilingual on-screen display menu
- ■ Advanced digital keystone correction and high quality full screen image re-scaling
- ■ User-friendly control panel
- ■ Video compatibility- NTSC/PAL/SECAM video capability with S-video, composite and HDTV (480i/p, 576i/p, 720p, 1080i)
- ■ Computer compatibility- SXGA, XGA compression and SVGA, VGA re-sizing
- ■ Pure digital DVD to projector connection
- ■ Built-in 5W x 2 stereo speaker
- ■ Optical digital audio output and stereo output
- ■ DVD player compatibility-

Media Compatibility: DVD, DVD-R, DVD+R, DVD-RW, DVD+RW, Audio CD, CD-R, CD-RW

Format Compatibility: DVD, VCD, SVCD, HDCD, CD, MP3, WMA, Kodak PhotoCD, JPEG

Package Overview

This projector comes with all the items shown below. Check to make sure your unit is complete.



Projector with lens cap



Composite Video Cable
1.8m (For USA and ASIA)



VGA Cable 1.8m
(For European)



Power Cord 1.8m



D-Sub to RCA Adapter
(For USA and ASIA)



SCART RGB/S-video
Adapter
(For European)



IR Remote Control



Due to the difference in applications for each country, some regions may have different accessories.



AA Battery x 2

Documentation:

- User's manual
- Warranty Card



Carrying Case

Product Overview

Main Unit



- | | |
|--------------------|---------------------|
| 1. DVD Cover | 7. DVD Panel |
| 2. Focus Ring | 8. Projector Panel |
| 3. Zoom Lens | 9. Connection Ports |
| 4. IR Receivers | 10. Power Socket |
| 5. Elevator Button | 11. Speakers |
| 6. Zoom Lever | |

Projector Panel

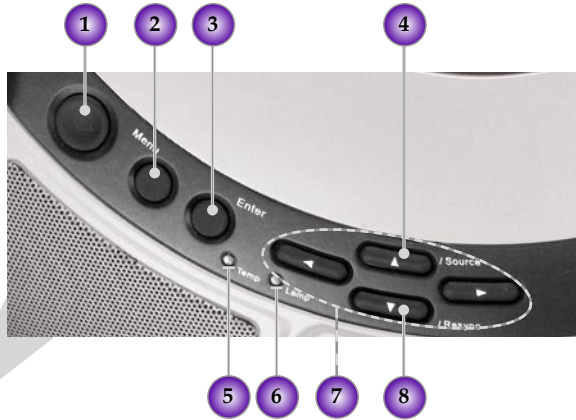

- 1. Power Button/Power LED
- 2. Menu
- 3. Enter
- 4. Source
- 5. Temperature LED
- 6. Lamp LED
- 7. Four Directional Select Keys
- 8. Resync

- 1. Stop
- 2. Play/Pause
- 3. Backward
- 4. Forward
- 5. DVD LED
- 6. Volume -
- 7. Volume +

DVD Panel

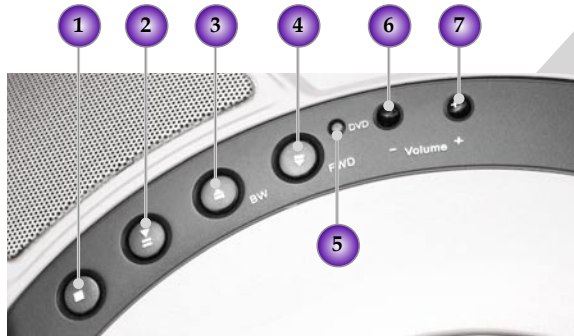

Connection Ports

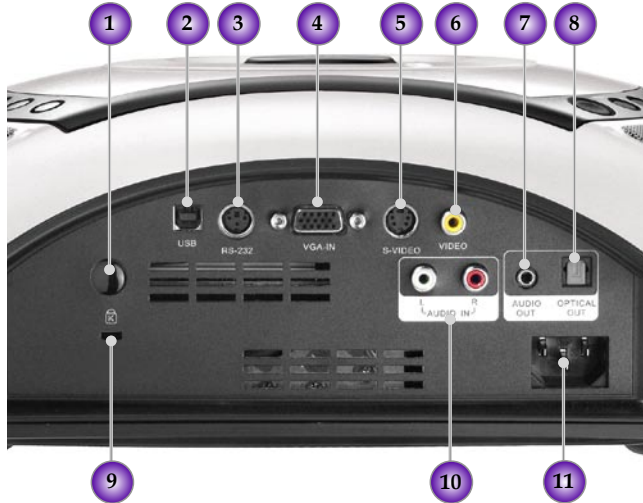

-
1. IR Receiver
 2. Service Connector
 3. RS232 Input Connector
 4. VGA Input Connector (PC Analog signal/SCART RGB/HDTV/Component Video)
 5. S-Video Input Connector
 6. Composite Video Input Connector
 7. Audio Output Connector
 8. Optical Audio Output Connector
 9. Kensington Microsaver™ Lock Port
 10. Audio Input Connector
 11. Power Socket
-

Remote Control

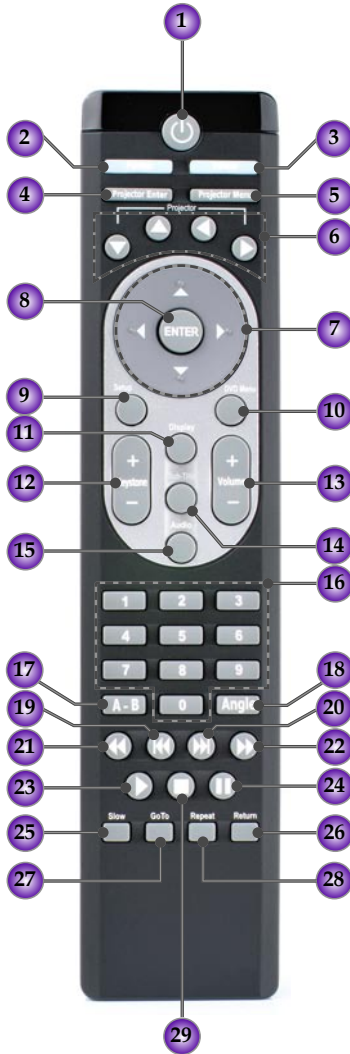

1. Power On/Off
2. Format
3. Source
4. Projector Enter Key
5. Projector Menu
6. Projector Four Directional Select Keys
7. DVD Four Directional Select Keys
8. DVD Enter Key
9. Setup
10. DVD Menu
11. Display
12. Keystone +/-
13. Volume +/-
14. Sub Title
15. Audio
16. Numerical Buttons
17. A-B Repeat
18. Angle
19. PREV Button
20. FWD Button
21. REW Button
22. NEXT Button
23. Play Button
24. Pause Button
25. Slow Button
26. Return Button
27. GOTO Button
28. Repeat Button
29. Stop Button

Setting up the Projector

Connecting the Computer/Notebook

1. Power cord
2. VGA cable

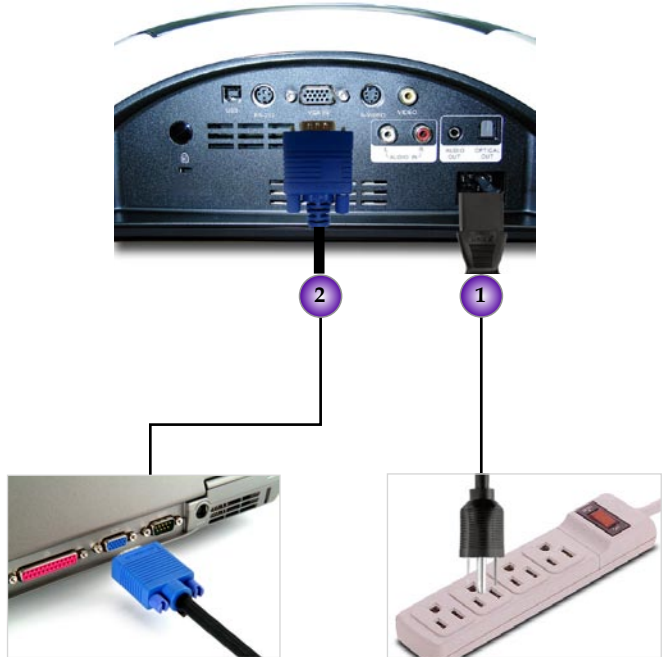

Connecting the Video

1. Power cord
2. Video cable
3. S-Video Cable
4. D-Sub to RCA Adapter
5. RCA Component Cable for YPbPr

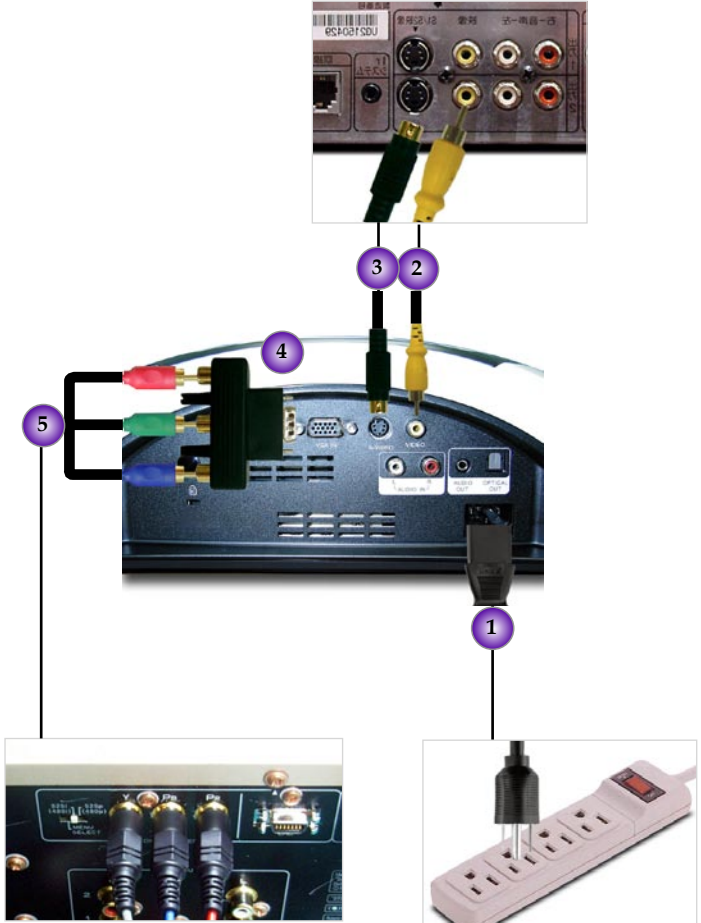

The user can install the connection port according to their environment of audio and video equipments or demand.

Connecting the Audio Input

- 1. Power cord
- 2. Audio cable (L/R)



Connecting the Audio Output- (External Subwoofer/Stereo System)

- 1. Power cord
- 2. Audio cable



Connecting the Audio Output- (2.1 Channel/5.1 Channel)

- 1. Power cord
- 2. Optical audio cable



Powering On/Off the Projector

Powering On the Projector

1. Remove the lens cap. ❶
2. Ensure that the power cord and signal cable are securely connected. The Power LED will flash blue.
3. Turn on the lamp by pressing [Power] button on the control panel. And the Power LED will turn blue. ❷

The first time you use the projector, you can select your preferred language from quick menu after the startup screen display.



4. Turn on your source (computer, notebook, video player, etc.), the projector will automatically detect your source.
- Use the "Source" button on the remote control or control panel to select your desired source.



Turn on the projector first and the signal sources next.



Turn On the DVD Player

1. Remove the lens cap.
2. Ensure that the power cord and signal cable are securely connected. The Power LED will flash blue.
3. Turn on the lamp by pressing [Power] button on the control panel. And the Power LED will turn blue.
If the DVD player load the disc, you will see a message "Read disc" displayed on the projector's screen. If the DVD player does not load the disc, the start-up screen will display on the projector's screen.
4. Press  [Open/Close] on DVD panel or to open disc loading tray. ❶
5. Place the DVD on the tray ❷, then press  [Open/Close] to close disc loading tray. ❸



❶



❷



❸

DVD compatibility type		
Type of disc	Diameter	Recorder
DVD	12cm/8cm	DVD data format: compressed digital audio + compressed digital video
SVCD	12cm	MPEG2 compressed digital audio + compressed digital video
VCD	12cm/8cm	MPEG1 compressed digital audio + compressed digital video
CD	12cm/8cm	CD-DA: digital audio
HD-CD	12cm	HD-CD: digital audio
MP3/JPEG	12cm	Compressed digital audio
WMA	12cm	Compressed digital audio
JPEG/Kodak	12cm	Digital Photo

Powering Off the Projector

- Press the [Power] button to turn off the projector lamp, you will see a message "Power off the lamp? Picture Mute" displayed on the projector's screen. Press the [Power] button again to confirm, otherwise the message will disappear after 5 seconds.

Please note that if the key ► is pressed instead, the projector will enter the "Picture Mute" mode and no image will be displayed. To exit the "Picture Mute" mode, press the [Power] button again.
- The cooling fans continue to operate for about 60 seconds for cooling cycle and the Power LED will turn blue. When the Power LED begins flashing, the projector has entered standby mode.

If you wish to turn the projector back on, you must wait until the projector has completed the cooling cycle and has entered standby mode. Once in standby mode, simply press [Power] button to restart the projector.

3. Disconnect the power cord from the electrical outlet and the projector.
4. The projector cannot be turned on immediately following a power off procedure.

Warning Indicator

- *When the "LAMP" indicator lights solid red, the projector will automatically shut itself down. Please contact your local reseller or service center.*
- *When the "TEMP" indicator lights solid red for about 20 seconds, it indicates the projector has been overheated. You will see a message "Projector Overheated. Lamp will automatically turn off soon." on the on-screen display. The projector will automatically shut itself down.
Under normal conditions, the projector can be switched on again after it has cooled down. If the problem persists, you should contact your local dealer or our service center.*
- *When the "TEMP" indicator flashes red for about 10 seconds, you will see a message "Fan fail. Lamp will automatically turn off soon." on the on-screen display. Please contact your local dealer or our service center.*

Adjusting the Projected Image

Adjusting the Projector's Height

The projector is equipped with three adjustable feet to modify the height of the projector.

To raise or lower the image :

1. Locate the elevator foot. Press the elevator button **1** to extend the foot so it may be adjusted.
2. While holding down the elevator button, adjust the foot to the desired height, **2** then release the button to lock the elevator foot into position.
3. Use **3** to fine-tune tilt-adjustment.
4. Lower the projector so it rests on its foot; adjust as needed.

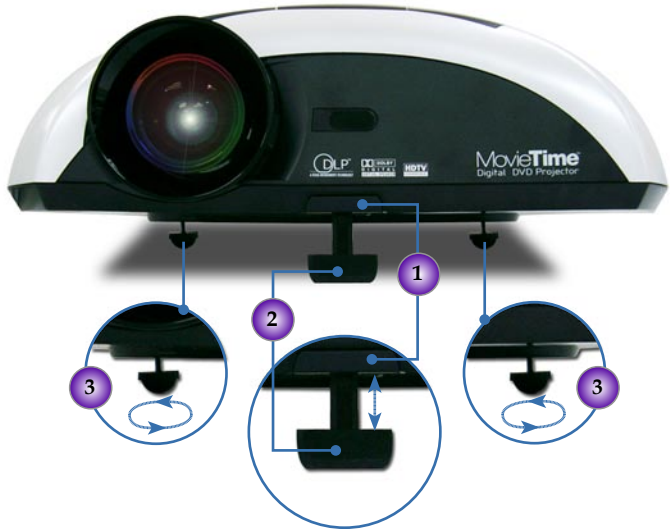

- xxxxxxxxxxxxxxxxxxxxxxxxxxxxxxxx
1. Elevator Button
 2. Elevator Foot
 3. Tilt-adjustment Foot
- xxxxxxxxxxxxxxxxxxxxxxxxxxxxxxxx

Adjusting the Projector's Zoom/Focus

Turn the Zoom Lever to zoom in or zoom out. To focus the image, turn the focus ring until you see a clear image. The projector will focus at distances from 3.28 to 32.80 feet (1.0 to 10.0 meters).

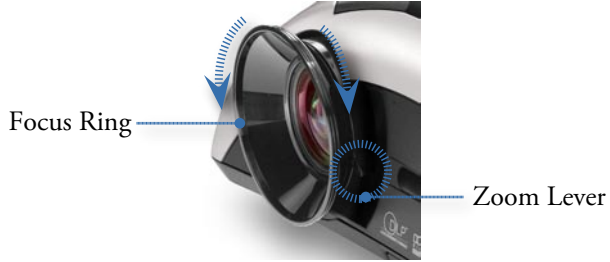

Adjusting Projection Image Size

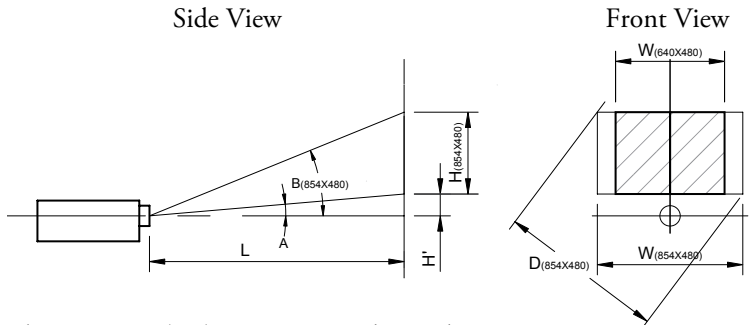

Throw Ratio (TR) = 1.26 as Wide mode

$$A = 13.52^\circ$$

$$B (854 \times 480) = 34.47^\circ$$

$$W (854 \times 480) = L / TR$$

$$W (640 \times 480) = W (854 \times 480) \times 0.75$$

$$H' = L \times \tan (A)$$

$$H (854 \times 480) = W (854 \times 480) \times 0.5625,$$

$$H (640 \times 480) = W (640 \times 480) \times 0.75$$

Display Format	A	B	L (cm)	W (cm)	H (cm)	H' (cm)	D (cm)	D (in)
16:9 -- 854 x 480	13.52	34.47	218.00	173.02	97.33	52.4	198.53	78.16
4:3 -- 640 x 480	13.52	34.47	218.00	129.77	97.33	52.4	162.21	63.86

Adjusting the Aspect Ratio of the Image

Depending on the type of video source you are viewing, the picture may or may not always look correct or fit on the screen:

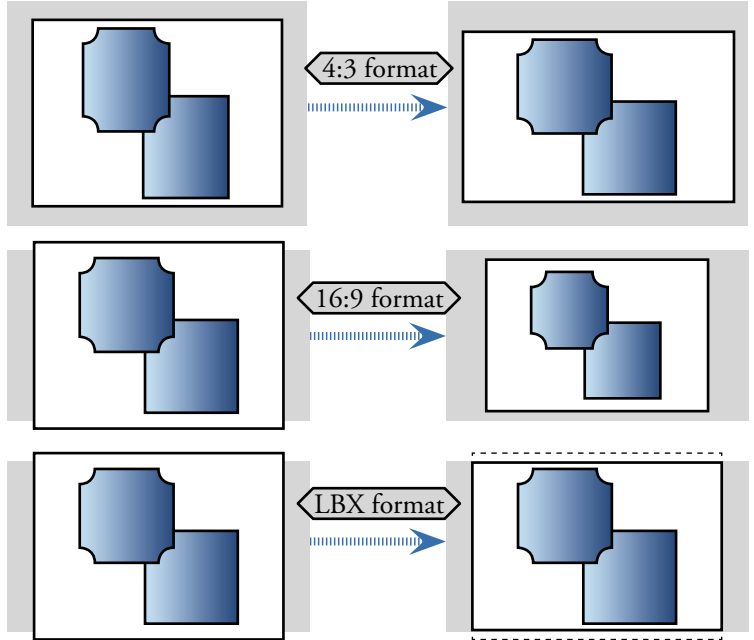

Adjusting the Sloping Image

If the projector is tilted up or down, the sides of the image on the screen might slope in or out, even though the top and bottom are level. Using the [Keystone] button to adjust the image.

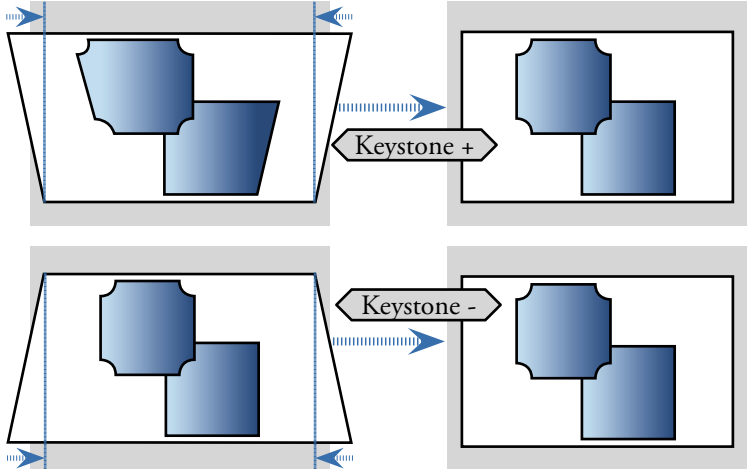

Control Panel & Remote Control

There are two ways for you to control the functions: with control panel and remote control.

Control Panel



Remote Control



Using the Remote Control

Power	Press [Power] to turns on the projector's lamp, refer to the "Powering On/Off the Projector" section on page 15~18 for more details.
Format	Display the [Format] section of the on-screen display menu to select the desired aspect ratio.
Source	Press to choose RGB, S-Video, Composite, Component, and HDTV sources.
Projector Enter	Confirm your item selection.
Projector Menu	Display or exits the on-screen display menus for projector.
Projector Four Directional Select Keys	Press [Projector Menu] then use ▲ ▼ ◀ ▶ to select items or make adjustments to your selection.
Keystone +/-	Adjusts image distortion caused by tilting the projector.
Volume +/-	Adjusts to increase/ decrease the volume.

DVD Four Directional Select Keys	Press [Menu] then use ▲▼◀▶ to select items or make adjustments to your selection.
DVD Menu	Return to DVD OSD menus
DVD Enter	Confirm your item selection.
Setup	Display or hide DVD OSD menus.
Display	Display DVD's states (title; chapter; time; information).
Sub Title	Select the desired your subtitle language.
Audio	Select the desired audio language or sound mode.
Numerical Buttons	Selects track numbers for playback.
A-B Repeat	Repeats playback of the selected section.
Angle Button	Choose the camera angle to see the sequence being played back from a different angle.
◀◀ REW Button	Press to search backward in x2/x4/x8/x20 speed.
◀◀ PREV Button	Press to skip to the previous title/chapter.
▶▶ NEXT Button	Press to skip to the next title/chapter.
▶▶ FWD Button	Press to search forward in x2/x4/x8/x20 speed.
▶ Play Button	Press to begin playback.
■ Stop Button	Press to stop playback.
 Pause Button	Press to pause playback. Press the ▶ [PLAY] button to resume normal playback.
Slow	Press to activate slow forward or slow rewind.
GOTO	Press to select the desired disc starting time, chapter or title.
Repeat	Repeats playback of the current disc, title, chapter or track.
Return	Returns to the previous operation.

Using the Projector Panel

Power	Press [Power] to turn on the projector's lamp, refer to the "Powering On/Off the Projector" section on page 15~18 for more details.
Power LED	Indicate the projector's status.
Lamp LED	Indicate the projector's lamp status.
Temp LED	Indicate the projector's temperature status.
Source	Press to choose RGB, S-Video, Composite, Component, and HDTV sources.
Resync	Automatically synchronizes the projector to the input source.
Projector Enter	Confirm your item selection.
Projector Menu	Display or exit the on-screen display menus for projector.
Projector Four Directional Select Keys	Press [Projector Menu] then use ▲ ▼ ◀ ▶ to select items or make adjustments to your selection.

Using the DVD Panel

Eject Button	Opens the top cover and stop playing.
◀◀ REW Button	Press to search backward in x2/x4/x8/x20 speed.
▶▶ NEXT Button	Press to search forward in x2/x4/x8/x20 speed.
▶ Play/Pause Button	Press to play/pause playback.
■ Stop Button	Press to stop playback.
Volume +/-	Increase/decrease the volume.

On-screen Display Menus

The Projector has multilingual On-Screen Display menus that allow you to make image adjustments and change a variety of settings. The projector will automatically detect the source.

How to Operate Projector Menu

1. To open the OSD menu, press [Projector Menu] on the Remote Control or press [Menu] on Control Panel.
2. When OSD is displayed, use ◀▶ keys to select any item in the main menu. While making a selection on a particular page, press ▼ key to enter sub menu.
3. Use ▲▼ keys to select the desired item and adjust the settings by ▶ key.
4. Select the next item to be adjusted in the sub menu and adjust as described above.
5. Press [Projector Menu]/[Menu] to confirm, and the screen will return to the main menu.
6. To exit, press [Projector Menu]/[Menu] again. If you don't press any key, the projector will automatically disappear after 30 seconds. The OSD menu will close and the projector will automatically save the new settings.

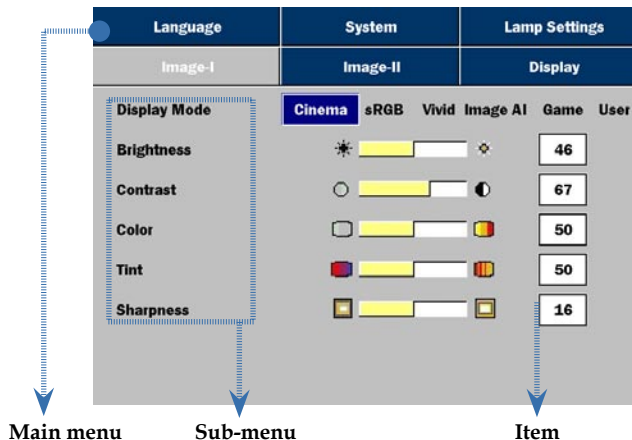

Menu Tree for Projector

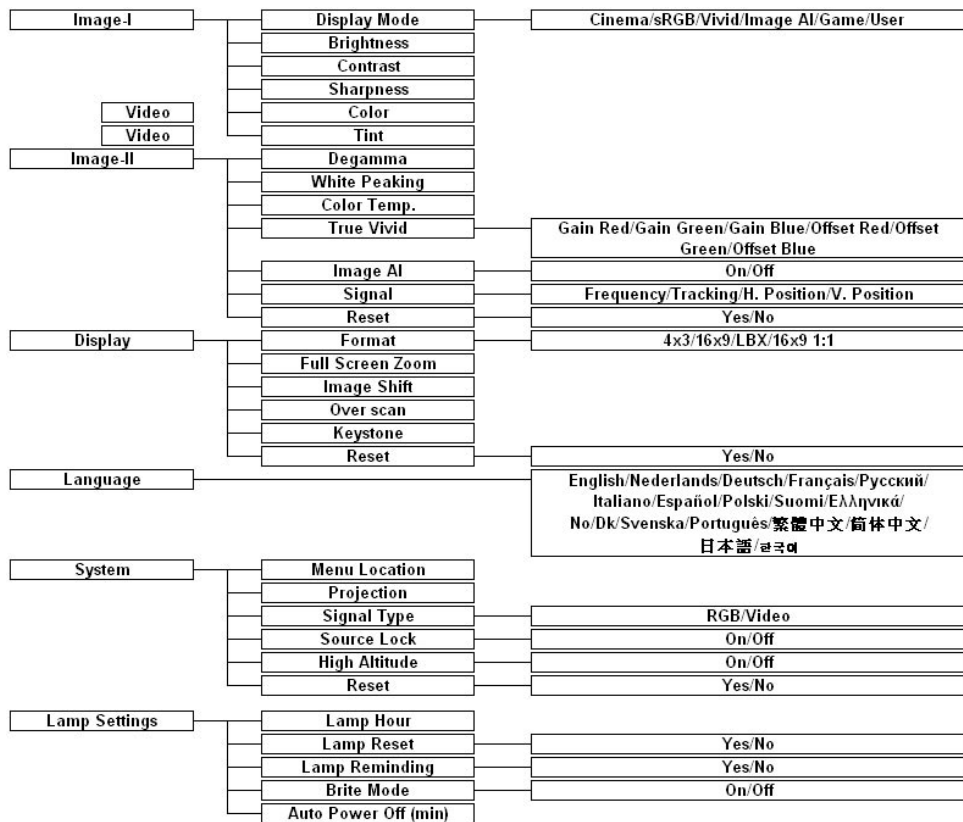

Image I	Image II	Display
Language	System	Lamp Settings
English		Português
Deutsch		Ελληνικά
Français		No/Dk
Italiano		Svenska
Español		日本語
Русский		繁體中文
Nederlands		简体中文
Polski		한국어
Suomi		

Language

Language

Display a multilingual menu. Use ◀ and ▶ to select your preferred language.

Press [Enter] to finalize the selection.

Language	System	Lamp Settings
Image-I	Image-II	Display
Display Mode	Cinema	sRGB Vivid Image AI Game User
Brightness		46
Contrast		67
Color		50
Tint		50
Sharpness		16

Image-I

Display Mode

There are many factory presets optimized for various types of images.

- Cinema: For home theater.
- sRGB: For computer or Notebook.
- Vivid: For dynamic frame.
- ImageAI: For Image AI function.
- Game: For game.
- User: Memorize user's settings.

Brightness

Adjust the brightness of the image.

- Press ◀ to darken an image.
- Press ▶ to lighten an image.

Contrast

Contrast controls the degree of difference between the lightest and darkest parts of the picture. Adjusting the contrast changes the amount of black and white with an image.

- Press ◀ to decrease the contrast.
- Press ▶ to increase the contrast.

Color

Adjust a video image from black and white to fully saturated color.

- Press ◀ to decrease the amount of color in an image.
- Press ▶ to increase the amount of color in an image.



The "Color" sub menu is not supported under the digital RGB input source.



The “Tint” sub menu is not supported under the digital RGB, component video or analog RGB input sources.

Tint

Adjust the color balance of red and green.

- Press ◀ to increase the amount of green in an image.
- Press ▶ to increase the amount of red in an image.

Sharpness

Adjust the sharpness of an image.

- Press ◀ to decrease the sharpness.
- Press ▶ to increase the sharpness.

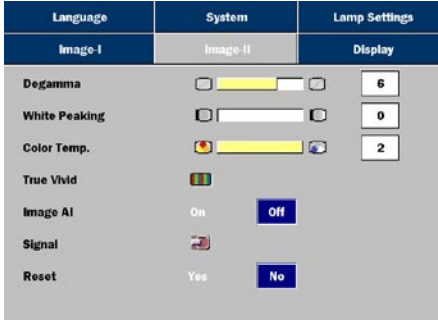

Image-II

Degamma

This allows you to choose a degamma table that has been fine-tuned to bring out the best image quality for the input.

White Peaking

Use the white peaking control to set the white peaking level of the DMD chip. "1" stands for minimal peaking, and "10" stands for maximum peaking. If you prefer a stronger image, adjust toward the maximum setting. For a smoother, more natural image, adjust toward the minimum setting.

Color Temp.

Adjust the color temperature. The range is from "0" to "2." At a higher temperature, the screen looks colder; at a lower temperature, the screen looks warmer.

True Vivid

Use ◀ or ▶ to select Red, Green, or Blue for brightness (Offset) and contrast (Gain).

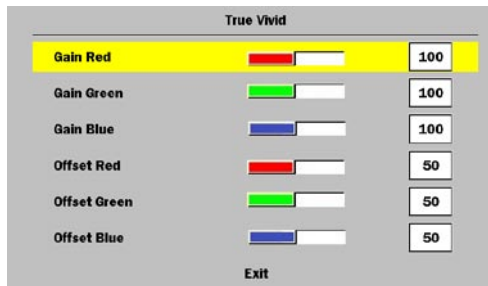
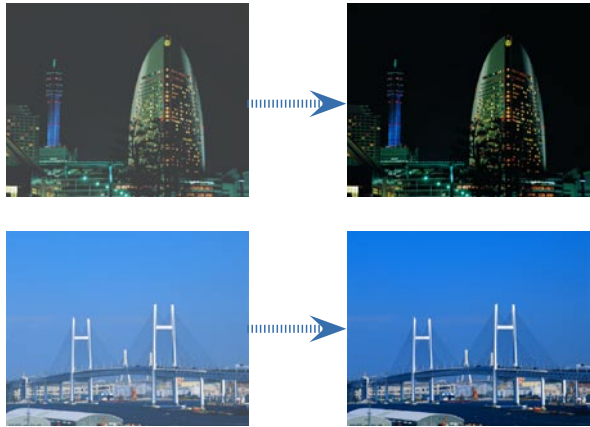

Image AI

Image AI is a magician of Image Performance Management for modern Home Use projectors, who can enable the vivid and bright projected image for brighter video content, and on the other hand also reveal the most dark details for dark video content without any performance compromise, by DYNAMICALLY adjusting Lamp Brightness Output, optimizing Brightness/Contrast settings and Gamma curve depending on the content of every single scene from the projected video source.

■ On: The dynamic image performance manager is active in making sure your greatest pleasure from seeing a movie dynamically with the most dark details revealed, vivid and bright image performed all the way.



■ Off: The dynamic image performance manager is standby.

Signal

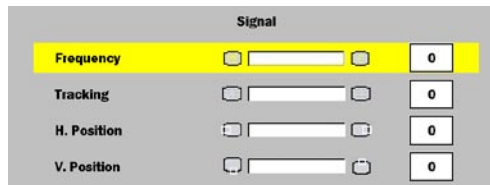



The "Signal" sub menu is supported under the Analog RGB and Analog YPbPr input sources.

- ■ Frequency: Changes the display data frequency to match the frequency of your computer's graphic card. When you experience a vertical flickering bar, use this function to make an adjustment.
- ■ Tracking : Synchronizes the signal timing of the display with the graphics card. If you experience an unstable or flickering image, use this function to correct it.
- ■ Horizontal: Adjusts the horizontal position.
- ■ Vertical: Adjusts the vertical position.

Reset

Choose "Yes" then "Enter" pressed, the display parameters on this menu will return to their factory default settings.

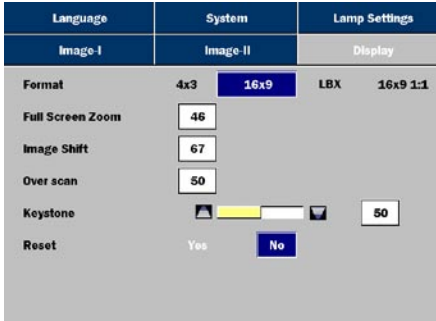

Display

Format

- 4x3: The input source will be scaled to fit the projection-screen.
- 16x9: The standard wide-screen display format of the projector.
- LBX: Enable the viewing of the letterboxed non-anamorphically enhanced movie at full screen width. Part of the original image will be lost if the image aspect ratio is less than 1.78:1.
- 16x9 1:1: This is especially useful for watching 2.35:1 movies of PAL 1024x576 or 1080i source for both sharper image and original resolution.

Source	480i/p	576i/p	1080i	720p	PC
4x3	Scale to 640x480				
16x9	Scale to 854x480				
LBX	Scale to 854x640, then center 854x480 image to display				
16x9 1:1	N/A	1024x576 centered	960x540 centered	1280x720 centered	N/A

Full Screen Zoom

Provide different magnification ratios to zoom an image. Image will be centered after zooming.

Image Shift

Shifts the projected image position vertically. 0 is middle of the screen.

Overscan

Mask off a few pixels on each edge of the image to be displayed. Use this function to adjust if image source happens to have encoded-







ing error near any edge of the displayable image.

Keystone

Adjust image distortion caused by tilting projector. (± 16 degrees)

Reset

Choose "Yes" then "Enter" pressed, the display parameters on this menu will return to their factory default settings.

Image-I	Image-II	Display
Language	System	Lamp Settings
Menu Location	    	
Projection	 	
Signal Type	RGB	Video
Source Lock	On	Off
High Altitude	On	Off
Reset	Yes	No

System

Menu Location

Choose the menu location on the display screen.

Projection

 **Front-Desktop**

The factory default setting.

 **Rear-Desktop**

When you select this function, the projector reverses the image so you can project from behind a translucent screen.

Signal Type

Select signal type RGB or Video sources.

Source Lock

When this function is turned off, the projector will search for other signals if the current input signal is lost. When this function is turned on, it will search specified connection port.

High Altitude

Choose "ON" to turn on High Altitude mode. Operates the fans at full speed continuously to allow for proper high altitude cooling of the projector.

Reset

Choose "Yes" then "Enter" pressed, the display parameters on this menu will return to their factory default settings.

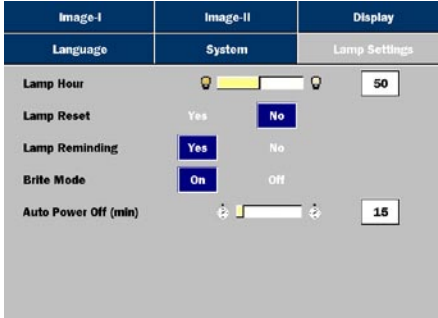

Lamp Setting

Lamp Hour

Displays the cumulative lamp operating time.

Lamp Reset

Reset the lamp setting only when the new lamp is replaced.

Lamp Reminding

Choose this function to show or to hide the warning message when the changing lamp message is displayed. The message will show up 30 hours before end of life.

Bright Mode

Choose "On" to increase the brightness and reduce the contrast ratio. Choose "Off" to return normal mode.

Auto Power Off (min)

Sets the interval of power-off of the system, if there is no signal input. (In minutes)

How to Operate WMA/MP3/JPEG Program

1. When you place the MP3/JPEG disc, the DVD player will automatically detect the program.
2. Prioritize to enter the first table of MP3 automatically. And play the first song under this file folder (Cursor suspend in "01" position)
3. Use ◀▶ keys to select the function menu. And the marked icon will turn transparency into full color.
4. Use ▲▼ keys to select the desired track. After the selected star, it will begin to flash.
5. Press [Enter]/[Play] button to play.
6. Press [Return] button to go back the program.

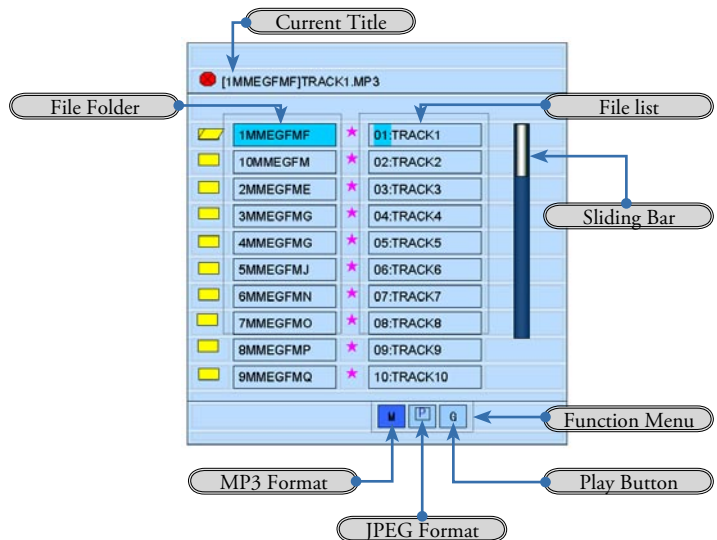

How to Operate DVD Menu

1. To open the DVD OSD menu, press [Setup] on the Remote Control.
2. When DVD OSD is displayed, use ◀▶ keys to select any item in the main menu. While making a selection on a particular page, press [Enter] or ▶ key to enter sub menu.
3. Use ▲▼ keys to select the desired item and adjust the settings by ◀▶ key.
4. Select the next item to be adjusted in the sub menu and adjust as described above.
5. Choose the “Exit Setup” to confirm, and the screen will return to the main menu.

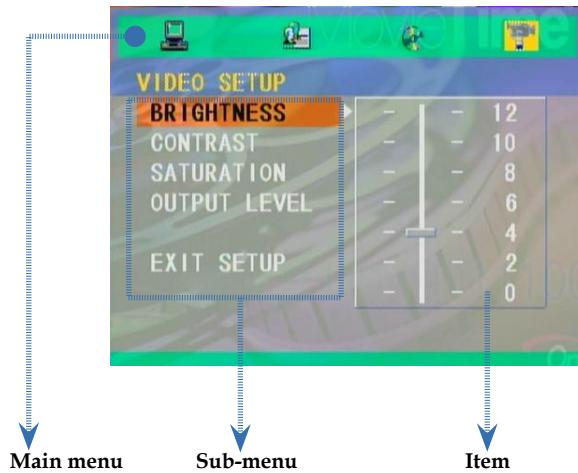

Menu Tree for DVD

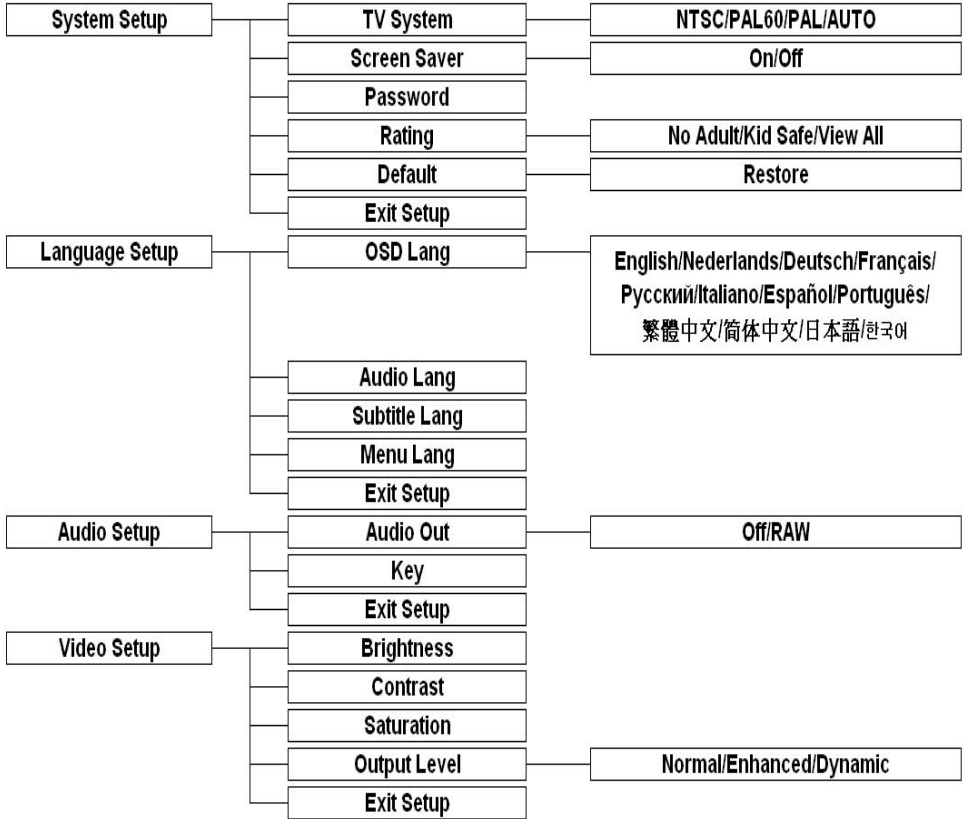

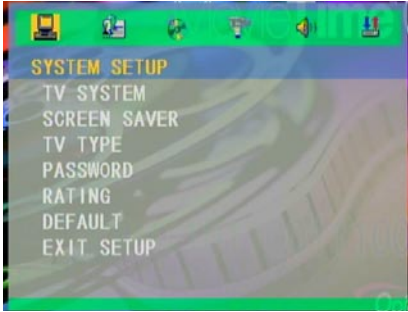

System Setup

TV System

Select system as you watching TV.

Screen Saver

Choose "On" to start the screen protection function, while stopping, opening, no discs or about 60 seconds of picture inactive state on the tray. Choose "Off" to cancel the screen saver function.



When you forget the old password, press the initial password "000000".

TV Type

Use this function to choose your desired type.

Password

The default setting is "Password is locked ", can't choose "Rating" or revise the password. If need to select "Rating" to press the numerical key and importing the initial password of the one machine: 000000, then press the enter button to confirm. When you need to change the password, input the old password first, and then input the new password. (The effective password is six bits)

Rating

According to the grade of the Videodisc divided and your actual demand to choose the fit rating for yourself.

Default

Choose "Restore" then "Enter" pressed, the display parameters on all menu will return to their factory default settings.

Exit Setup

Exit this menu.

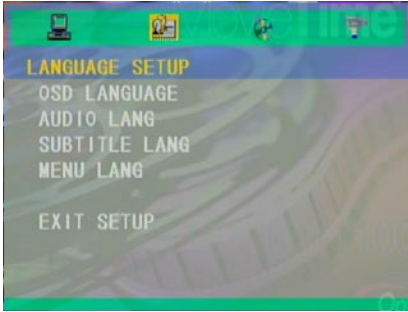

Language Setup

OSD Language

Select your preferred language for the on-screen display menu.

Audio Lang

Select the audio language

Subtitle Lang

Select the subtitle language

Menu Lang

Select your preferred language for DVD menu.

Exit Setup

Exit this menu.



Audio Setup

SPDIF Out

Choose the appropriate Audio settings for your equipment as it only affect during the playback of DVD discs of the DVD player.

- Off: Turn off the sound.
- RAW: Select this function, when the player is connected to Dolby Digital Decoder. The default is RAW.

Key

Adjust the key of sound.

Exit Setup

Exit this menu.



Video Setup

Brightness

Adjust the brightness of the image.

- Press ◀ to darken an image.
- Press ▶ to lighten an image.

Contrast

Contrast controls the degree of difference between the lightest and darkest parts of the picture. Adjusting the contrast changes the amount of black and white with an image.

- Press ◀ to decrease the contrast.
- Press ▶ to increase the contrast.

Saturation

Adjust the color balance of red and green.

- Press ◀ to increase the amount of green in an image.
- Press ▶ to increase the amount of red in an image.

Output Level

There are three factory presets optimized for various types of pictures: Normal, Enhanced and Dynamic.

- Press ◀ to decrease the amount of color in an image.
- Press ▶ to increase the amount of color in an image.

Exit Setup

Exit this menu.

Troubleshooting

If you experience a problem with your projector, please refer to the following information. If a problem persists, please contact your local reseller or service center.

Image Problems

[?] No image appears on screen:

- Ensure that all the cables and power cord are correctly and securely connected as described in the “Installation” section.
- Ensure that connector pins are not bent or broken.
- Check the [Power] button is pressed.
- Make sure that the projection lamp has been securely installed. Please refer to the “Replacing the lamp” section.
- Ensure that you have removed the lens cap and that the projector is powered on.

[?] Partial, scrolling, or incorrectly displayed images:

- Press [Re-Sync] on the control panel.
- If using a PC:

For Windows 3.x:

1. In the Windows Program Manager, double click the “Window Setup” icon in the Main group.
2. Verify that your display resolution setting is less than or equal to 1280 x 1024.

For Windows 95, 98, 2000, XP:

1. Open the “My Computer” icon. Next, open the “Control Panel” folder, and double click the “Display” icon.
2. Select the “Settings” tab.
3. (Above in “Windows 3.x). Click on the “Advanced Properties” button. Verify that your display resolution setting is less than or equal to 1280 x 1024.

If the projector is still not projecting the image, you may need to adjust your monitor display setting. To do this, please refer to the following instructions.

4. Verify the resolution is less than or equal to 1280 x 1024.
 5. Select the "Change" button under the "Monitor" tab.
 6. Click on "Show all devices." Next, select "Standard monitor types" under the SP box; choose the resolution mode you need under the "Models" box.
 7. Verify that the resolution setting of the monitor display is less than or equal to 1280 x 1024.
- If using a Notebook PC:
 1. First, follow the steps above to adjust resolution of the computer.
 2. Switch the Notebook PC display to the "external display only" or "CRT only" mode.
 - If you experience difficulty changing resolutions or your monitor freezes, restart all the equipment including the projector.

[?] The screen of the Notebook or PowerBook computer is not displaying your presentation:

■ If using a Notebook PC:

Some Notebook PCs may deactivate their own screens when a second display device is in use. Each has a different way of reactivating. Refer to your computer's documentation for detailed information.

[?] Image is unstable or flickering:

- Use "Phase" to correct it. See page 33 for more information.
- Change the monitor color setting on your computer.

[?] Image has a vertical flickering bar:

- Use "Tracking" to make an adjustment. See page 33 for more information.
- Check and reconfigure the display mode of your graphics card to ensure compatibility.

[?] Image is out of focus:

- Make sure the lens cap is removed.
- Make sure the projection screen is between the required distance 3.3 to 32.8 feet (1.0 to 10.0 meters) from the projector.

[?] Image is too small or too large:

- Adjust the zoom lever on the top of the projector.

- Move the projector closer to or farther from the screen.
- Press [Format] button on the remote control or [Projector menu] on the projector panel, go to “Display-->Format”. Try the different settings.

[?] Image has slanted sides:

- As possible, reposition the projector so that it is centered on the screen and below the bottom of the screen.
- Press [Keystone +/-] button until the sides are vertical on the remote control.

Intermission Problems

[?] The projector stops responding to all controls:

- If possible, turn off the projector, then unplug the power cord and wait at least 20 seconds before reconnecting power.

[?] Lamp burns out or makes a popping sound:

- When the lamp reaches its end of life, it will burn out and may make a loud popping sound. If this happens, the projector will not turn on until the lamp module has been replaced. To replace the lamp, follow the procedures in the “Replacing the Lamp” section on page 50.

LED Problems

[?] LED lighting message:

Message	Power LED (Blue)	Temp LED (Orange)	Lamp LED (Red)
Standby State (Input power cord)	Flashing	○	○
Power On/Lamp lighting	☀	○	○
Power Off/Cooling	☀	○	○
Error (Thermal Failed)	☀	☀	○
Error (Fan Failed)	☀	Flashing	○
Error (Lamp Failed)	☀	○	☀

? Message Reminders

- “Lamp is approaching the end of its useful life in full power operation. Replacement Suggested!” will be shown about 10 seconds, when lamp is nearing end of life.
- “Projector Overheated. Lamp will automatically turn off soon.” will be shown when the system temperature is too high.
- “Fan Fail” will be shown momentarily before shutdown if fan is out of order.

DVD Player Problems

? If a message show an error message:

- Make sure the disc is inserted with the label facing up.
- Make sure the disc is completeness, not scratch, dirtiness or warp.
- The type of disc you inserted might not be supported by the internal DVD player. If so, you can not play this type of disc. Try a different disc.
- For a DVD, check its region code. Most DVDs have a region code marked near the center hole. Compare its region code with the region code for a DVD that plays properly on your projector. The projector can play DVDs from only one region.

? If a disc does not automatically play:

- A disc automatically starts playing only at the time you close the tray. If a disc is already loaded in the tray, press the [Play] button to start playing.
- Make sure the [Power] button is pressed. If the projector is powered off, nothing happens to the internal DVD player.

? If a disc skips and does not continuously play:

- Check the DVD player isn't in [A-B] repeat status.
- Make sure the disc is completeness, not scratch, dirtiness or warp. If so, try to clean disc or press [GOTO] button to skip to next chapter or title.

? If some images on a CD do not show:

- Some images with very high resolution (high number of pixels) cannot be displayed. Convert them to standard format with a lower resolution.

Sound Problems

[?] If no sound from the projector:

- If you are playing an external source, make sure you have an audio cable securely connected between the source device and the projector's audio input.
- Make sure the headphone is not connected.
- Make sure the volume is not set to minimum.
- Make sure the "Audio Setup-->SPDIF Out" function is not set to Off.
- Make sure the DVD player is not in pause status.

Remote Control Problems

[?] If the remote control does not work:

- Check the operating angle for the remote control is approximately $\pm 30^\circ$ horizontally and approximately $\pm 15^\circ$.
- Make sure there are not any obstructions between the remote control and the projector. Move to within 6 m (20 ft) of the projector.
- Make sure batteries are inserted correctly.
- Make sure batteries are exhausted. If so, replace weak batteries in the remote control.

Replacing the Lamp

The projector displays a warning message "Lamp is approaching the end of its useful life in full power operation. Replacement Suggested!" When you see this message, please contact your local reseller or service center.

Make sure the projector has cooled down for at least 30 minutes before changing the lamp.



Warning:

Lamp compartment is hot! Allow it to cool down before changing lamp!

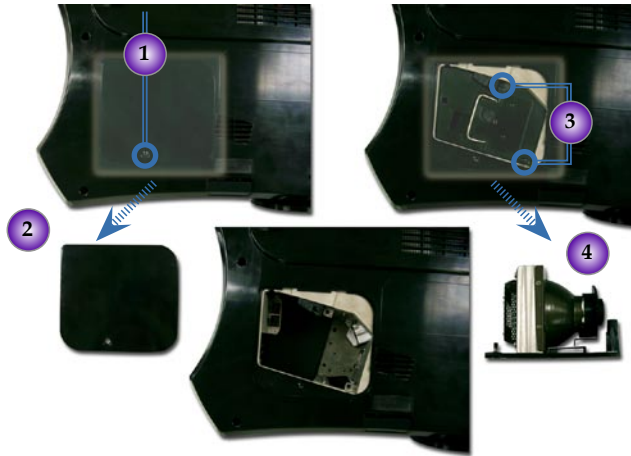

Warning: To reduce the risk of personal injury, avoid dropping the lamp module or touching the lamp bulb. If dropped, the bulb may shatter and cause injury.

Lamp Replacing Procedure:

1. Turn off the power to the lamp by pressing the power button.
2. Allow the projector to cool down at least 30 minutes.
3. Disconnect the power cord.
4. Use screwdriver to remove the screw from the cover. ❶
5. Remove the cover. ❷
6. Unscrew 2 screws from the lamp module. ❸
7. Pull out the lamp module. ❹

To replace the lamp module, reverse the above mentioned steps.